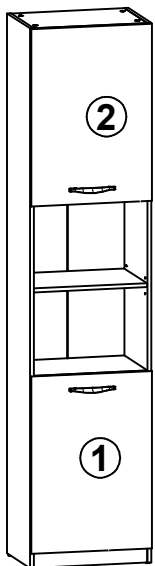
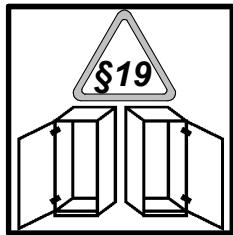
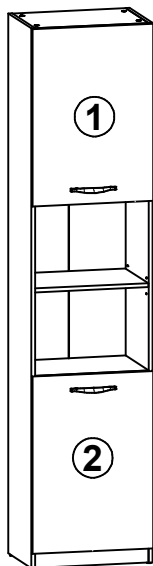
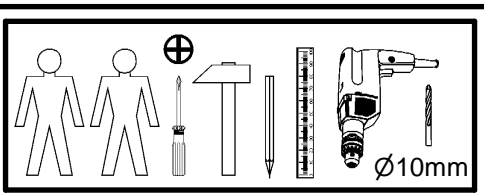
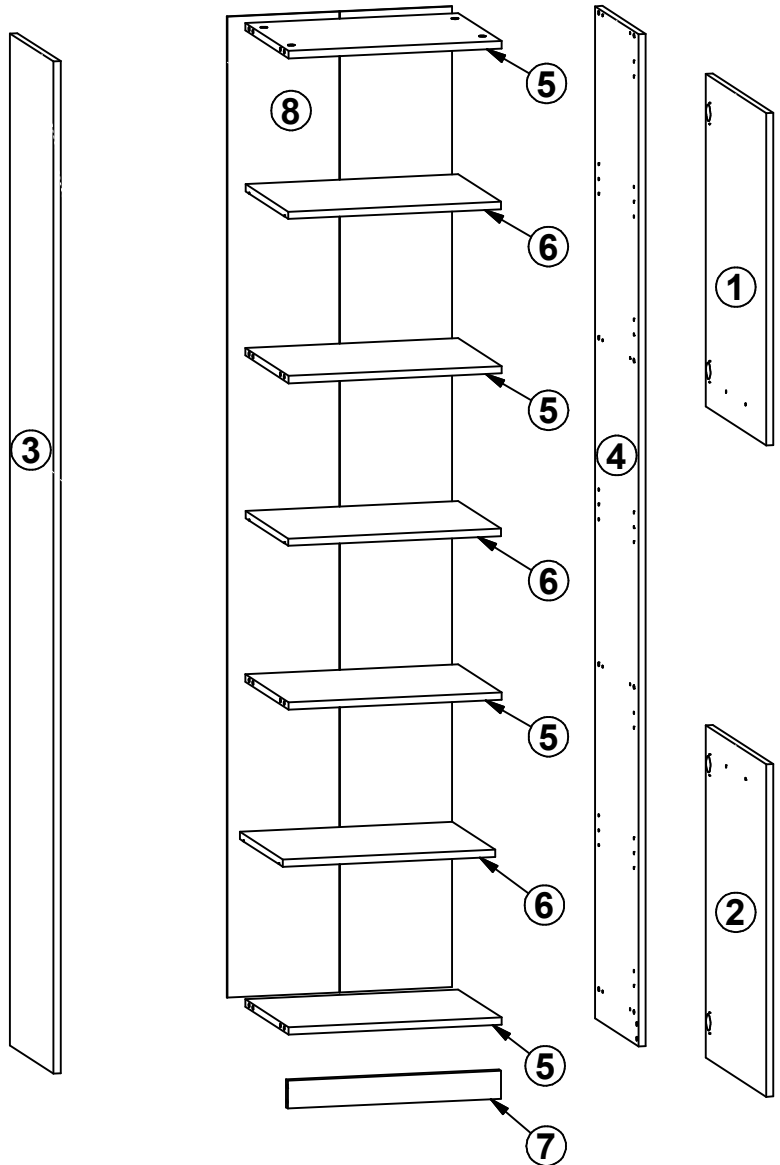

A**EXECUTIVE****S340-REG2D/22/5**

A	B	C	D
1	S340-0003	716	495 3/3
2	S340-0004	716	495 3/3
3	S340-1003	2180	355 1/3
4	S340-1004	2180	355 1/3
5	S340-3004	467	354 2/3
6	S340-3006	466	350 2/3
7	S340-4006	467	60 2/3
8	S340-9302	2113	493 1/3

**L****R**

4x a44	4x b35	2x 160 mm c432	12x Ø5x17 mm d1	20x Ø8x30 mm f1	4x M4x20 mm j1	4x k1	60x l1	8x Ø3.5x15 mm p51
16x Ø15x12 mm #16 r1	16x r42	8x s2	4x silikon o21					

1x n26\1	1x Ø3.5x16 mm p38
-------------	-------------------------

1

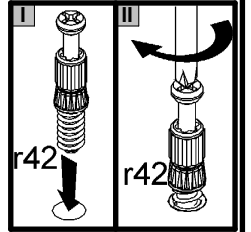
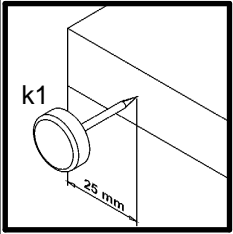
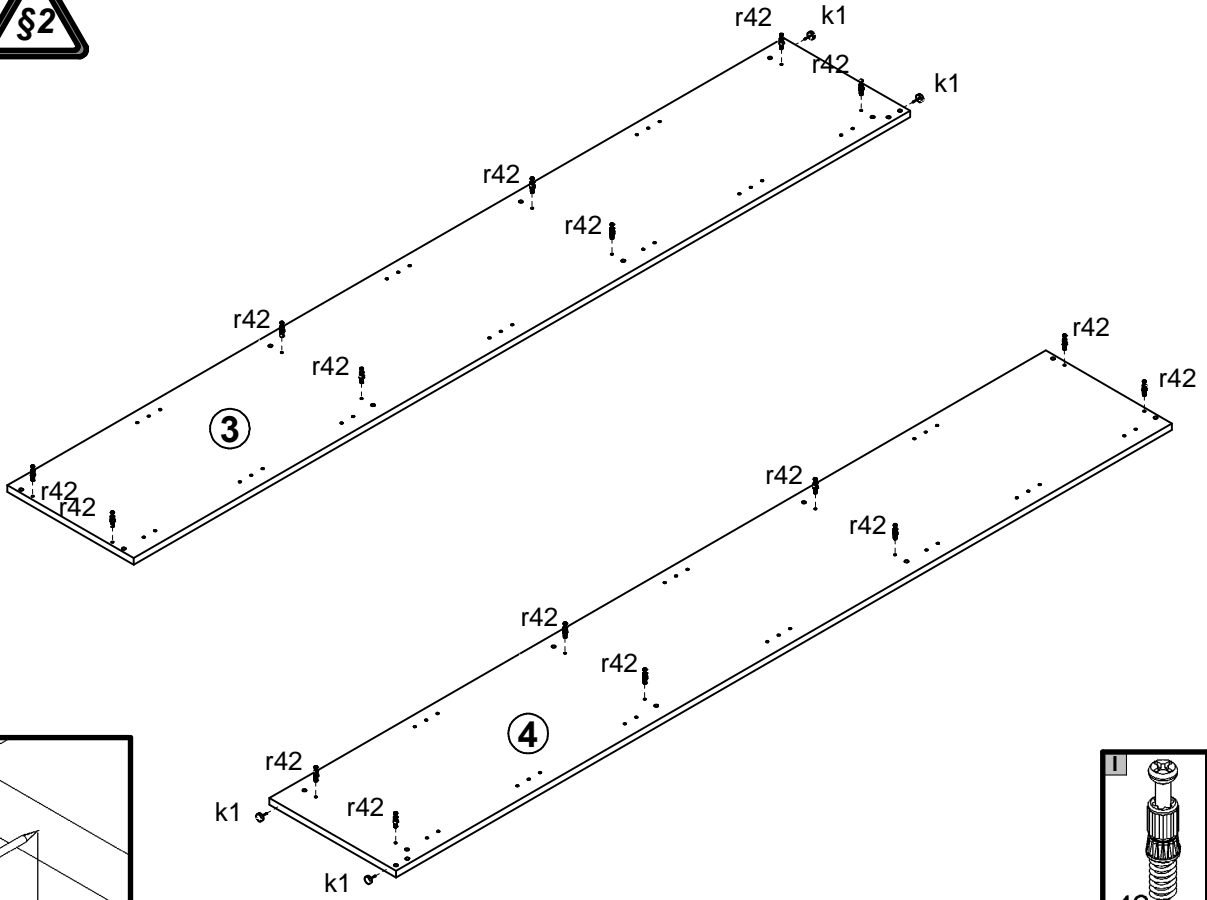

2

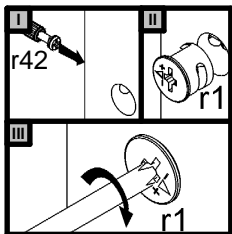
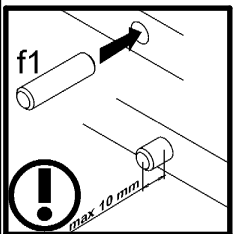
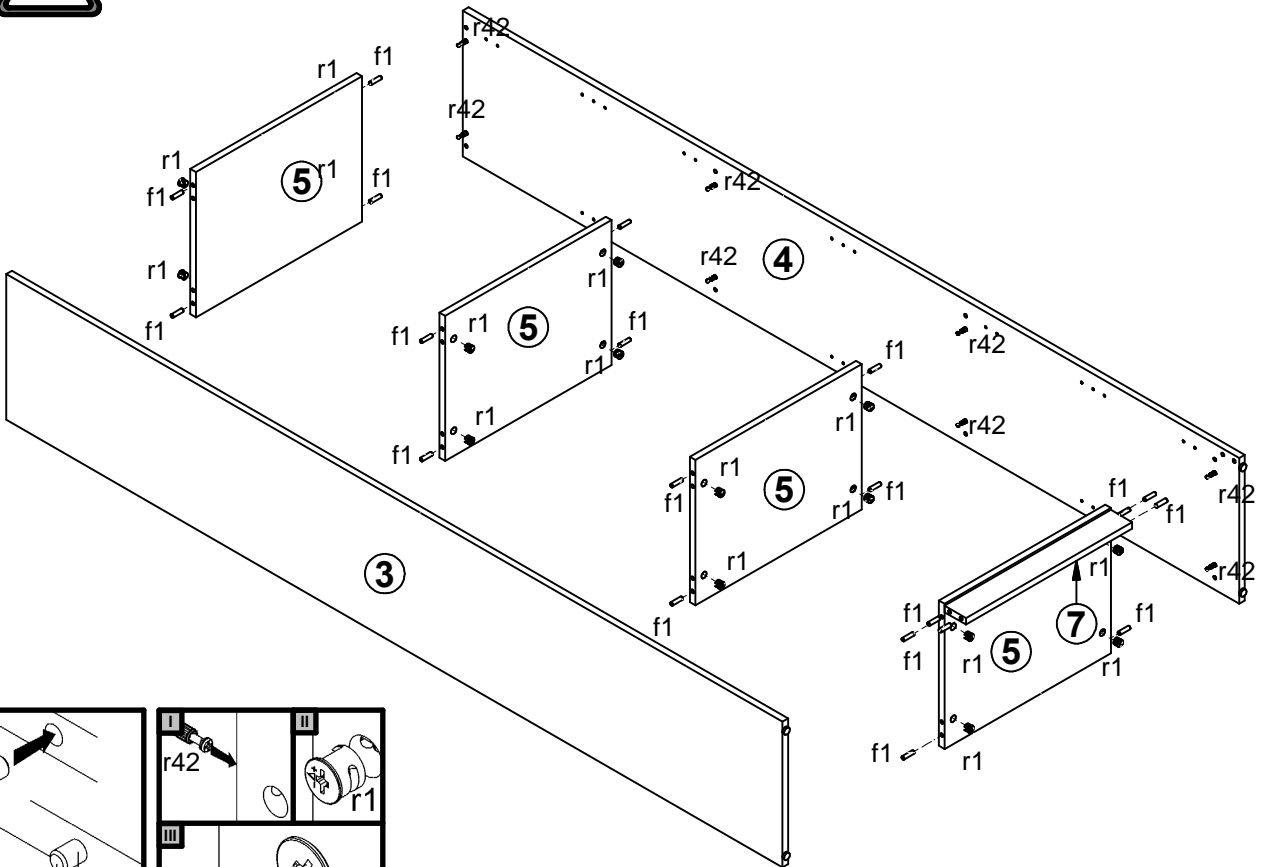

3

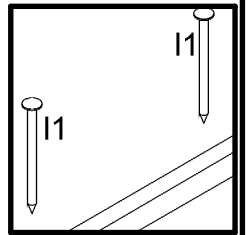
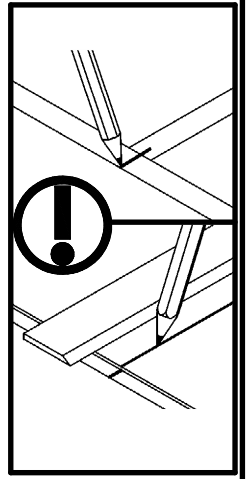
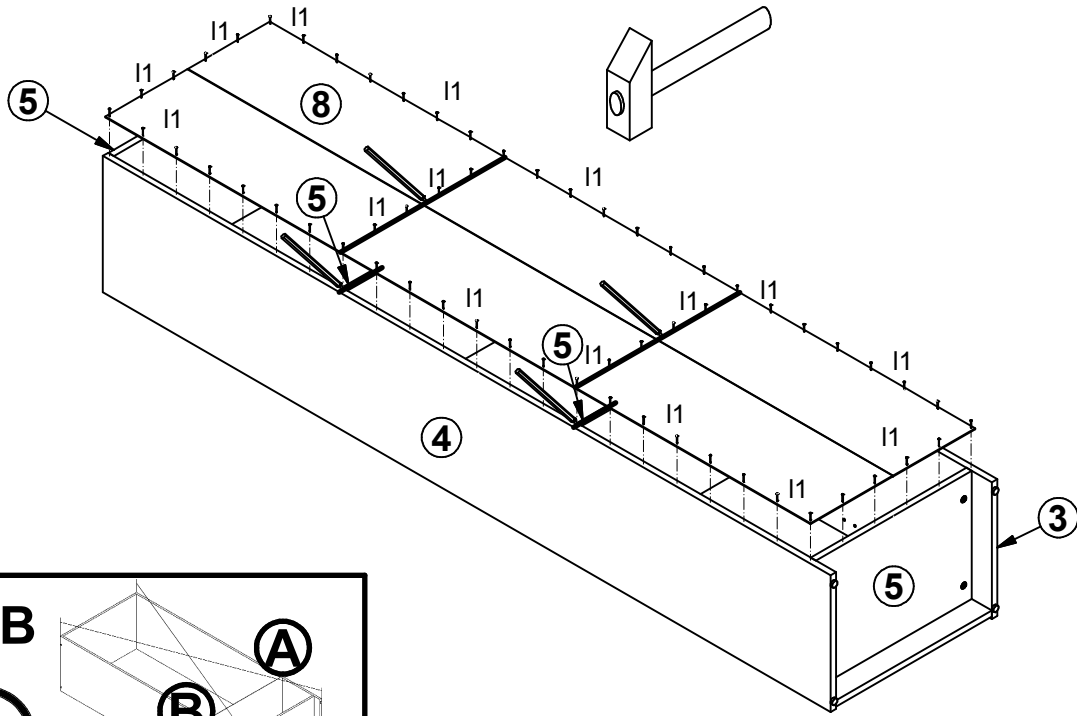

A=B

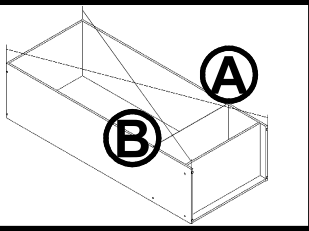

4

L

R

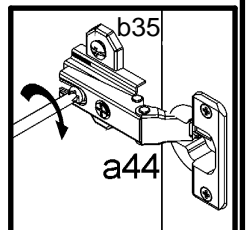
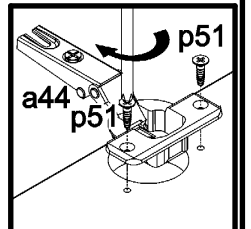
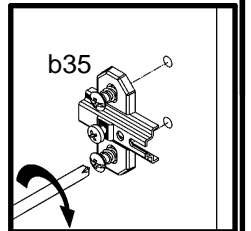
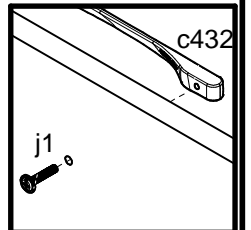
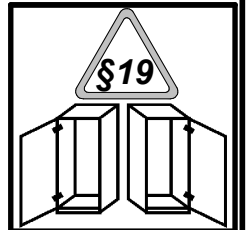
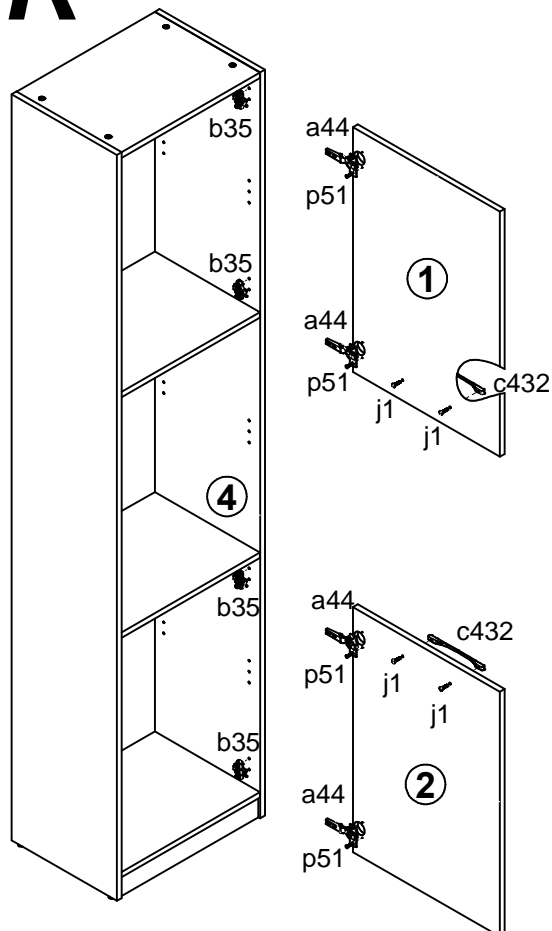
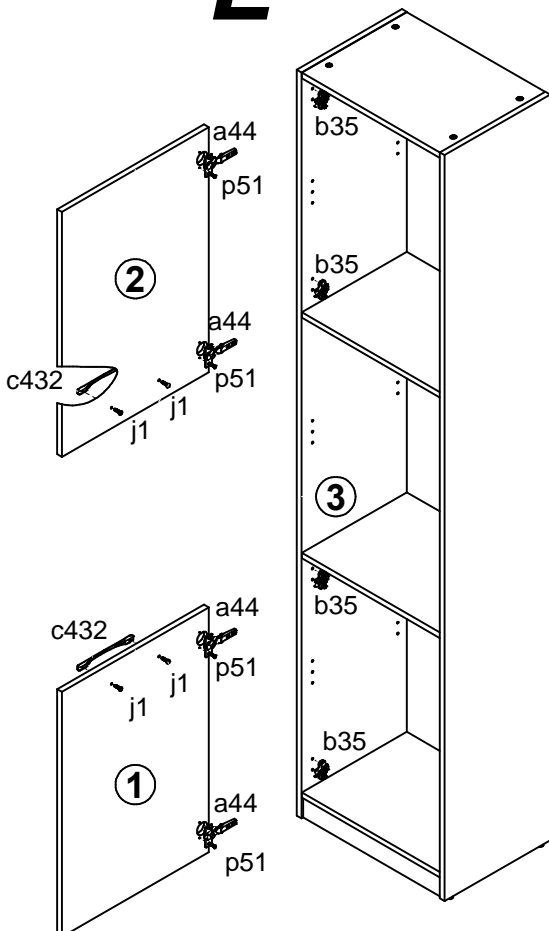

5

