

A**S221-P/1/9**

2 / 4

**30min**

A	B	C (mm)		D
1	S221-356	947	230	1/1
2	S221-452	948	120	1/1

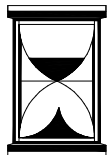
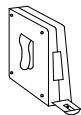
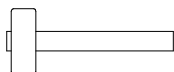
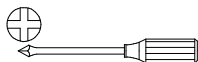
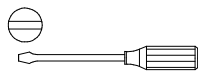
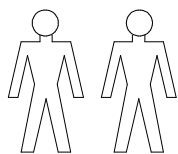
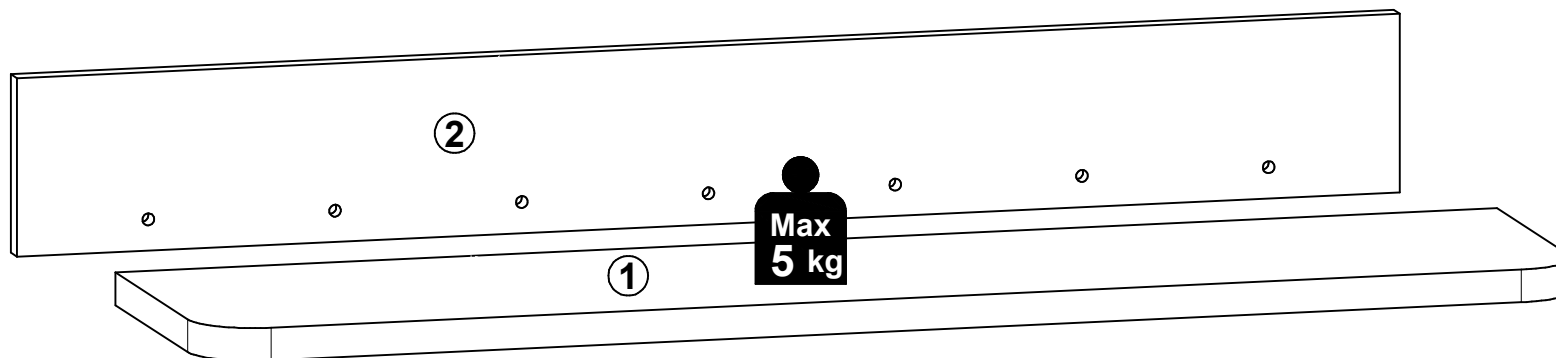
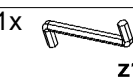
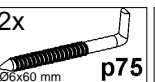
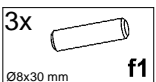
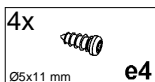
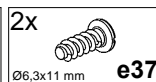
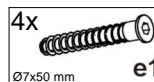

1

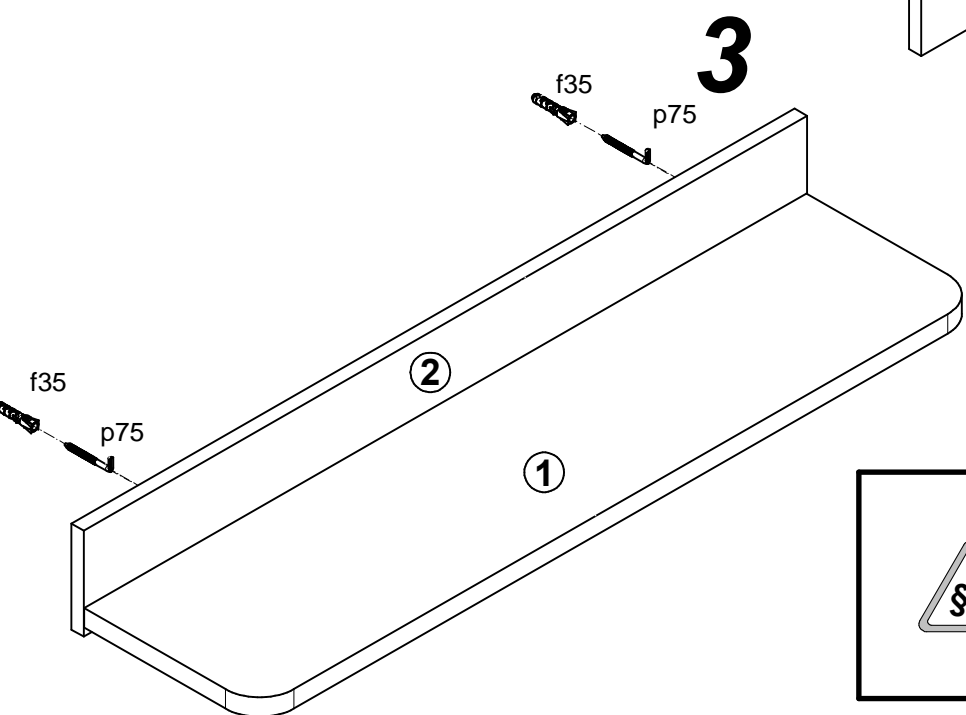
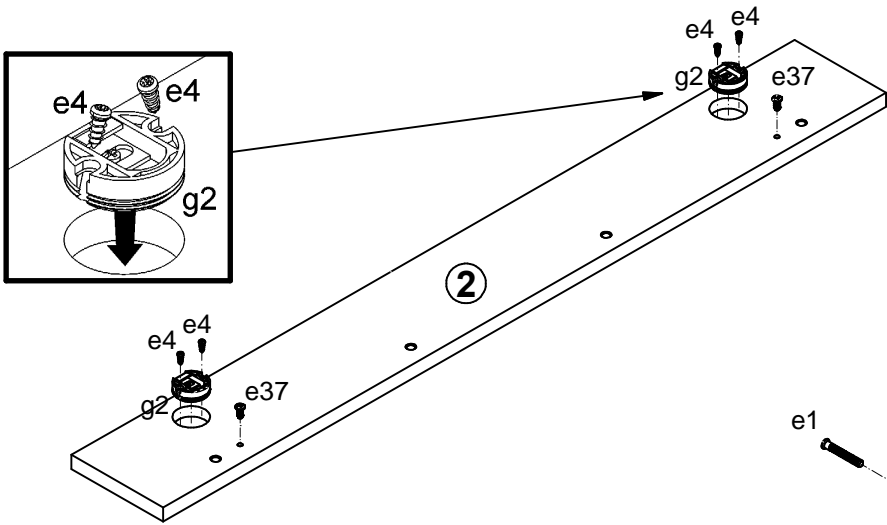

2

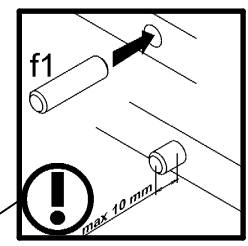
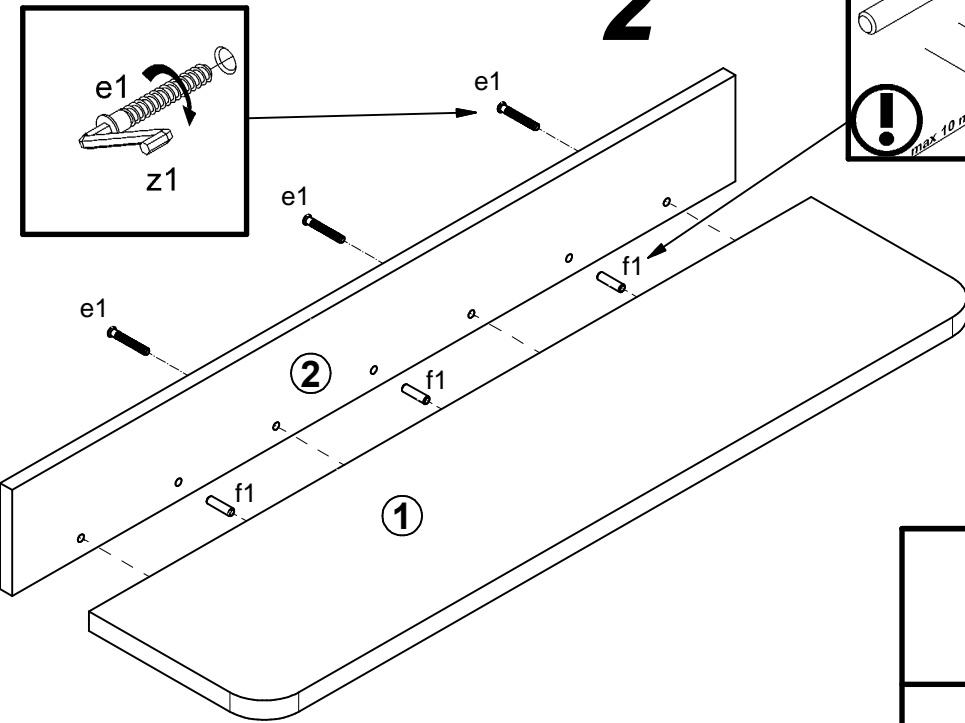
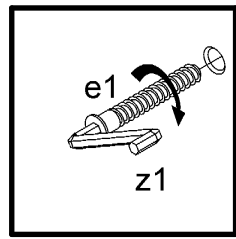

3

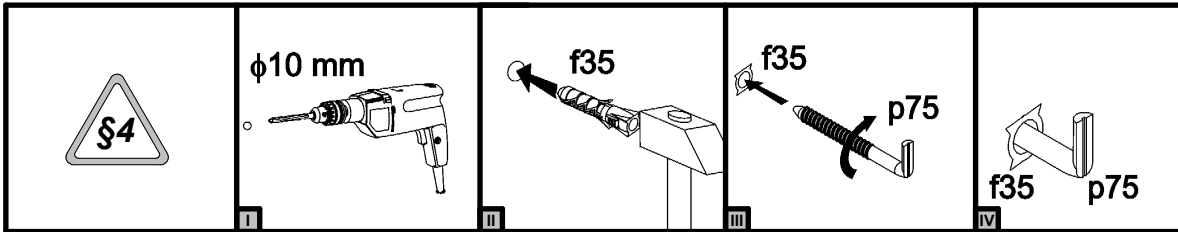
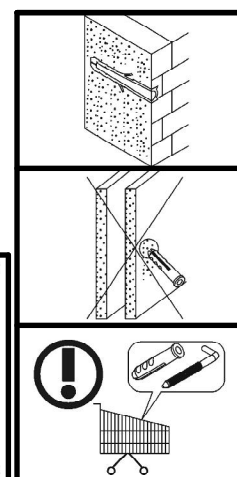
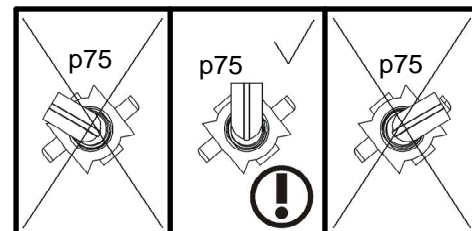

4

